

Saunadome



(GB) Installation and operating manual

Table of Contents

Intended use	3
General notes	3
Important notes	4
Electrical connection	5
Technical data	6
Wiring diagram for sauna heaters	7
Detailed wiring diagram for sauna heaters	7
Assembly	8
Minimum clearances	8
Electrical connection	8
Sauna stones	9
Maintenance and care	10
Service Address:	11
Guarantee	11
Handling procedures for return shipments (RMA) - Details for all returns !	12

Dear Customer,

You have purchased a high quality technical system which will provide you with many years of enjoyable sauna bathing. This sauna heating system was constructed in accordance with state-of-the-art European safety standards, inspected and manufactured in accordance with the Quality Standard DIN EN ISO 9001:2000.

This detailed installation and user's guide was created for your information. Please note especially the important information and the data dealing with the electrical connection.

We wish you a richly invigorating and restorative sauna bathing experience.

First of all, check whether the sauna system has arrived at your site undamaged. Register transport damage claims immediately with the delivering transport company or please consult the supplier who provided the equipment to you.

Intended use

This sauna heater is exclusively designed for the heating of sauna cabins, in connection with an appropriate control unit.

Any use apart from the defined application shall be regarded as non-intended use. Adherence to the conventional operating, maintenance and servicing conditions is also part of the intended use.

The manufacturer cannot be made responsible for deviating alterations undertaken on the authority of the user and any consequential damage. The risk for such measures shall be borne solely by the person carrying out the alterations and causing the damage.

Sauna heaters, with the exception of those used for household purposes, must be equipped with a safety device vis-à-vis the cover per DIN EN 60335-2-53.

As suitable measure, and depending on the sauna heater, a rocker switch Type I or Type II may be installed above the heater.

(The rocker switch is not included in the delivery scope of the sauna heater.)

For installation and electrical connection of the rocker switch follow the installation instructions supplied with this part.

General notes

Please note that an optimal sauna climate can be reached only when the cabin, with its air intake and exhaust, the sauna heating unit and the control unit have been tuned for compatibility with one another.

Please note all data and information provided by your sauna supplier.

The sauna heating units warm your sauna cabin through means of heated convection currents. To this end, fresh air from the air intake vent is drawn in, rises upon warming (convection) and is then circulated through the cabin. A part of the used air is pushed out through the exhaust vent in the cabin. This is the means by which the typical sauna climate develops, reaching characteristic temperatures of about 110° C directly under the ceiling of your sauna, which fall off to about 30-40° C in the floor area due to the temperature gradient in the sauna cabin. Therefore, it is not unusual when, for example, temperatures of 110° C prevail in the area of the temperature sensor over the oven, while the thermometer, which is installed 20-25 cm under the cabin ceiling on the sauna wall, registers only 85° C. With a temperature setting at maximum, the mean bathing temperature lies between 80° C and 90° C in the area of the upper recliner bench.

Please note that the highest temperature values in the cabin always develop in the area above the sauna heating unit and that the temperature sensor and safety limiter must be installed in this area in accordance with the control unit installation guide.

At the initial heating, you may notice a slight odor arising from evaporation of substances from the manufacturing process. Air out your cabin after this cycle before you begin with the sauna bath





Important notes



If assembled incorrectly, the system will present a fire hazard. Please read this installation guide thoroughly. It is especially important to consider applicable dimensions and observe the following instructions:

- This device has not been designed for being used by persons (including children) that are physically or mentally handicapped or have sensory disabilities. Moreover, it is not allowed to use this device without sufficient experience and/or knowledge, unless these persons will be supervised by persons responsible for their security or in case they have been instructed how to use this device.
- Children are to be supervised in order to make sure that they do not play with this device.
-  The installation and connection of the sauna heating unit, control unit and other electrical equipment must be accomplished only by an expert. In this regard it is especially important to meet the required safety precautions in accordance with VDE 0100 v. §49 DA/6 and VDE 0100 part 703/2006-2.
- The sauna heating and control units may be installed only in sauna cabins made of suitable, low resin and untreated material (for example: Nordic pine)
- Only a sauna oven with the appropriate heating capacity may be installed in the sauna cabin (see Table 2).
- There should always be a provision for air intake and exhaust vents in every sauna cabin. The air intake vents must always be aligned behind the sauna heating unit, ca. 5 to 10 cm above the floor. Please use the minimum dimensions of the air intake and exhaust vents listed in Table 1.
- The exhaust vents must always be placed towards the sauna heating unit diagonally in the rear sauna wall, lower area. The

air intake and exhaust vents must not be closed. Please observe the information provided by your sauna cabin supplier.

- For the adjustment and control of the sauna heating unit, one of the control units mentioned later must be used. This control unit must be attached to a suitable location on the outer wall of the cabin, the associated sensor housings in the interior of the sauna cabin in accordance with the installation guide which accompanies the control units.
-  Caution: Covering and improperly filled stone receptacles present a fire hazard.
-  Make certain that no objects have been placed on the sauna heating unit before each start-up.
-  Caution: High temperatures on the heating unit during operation can cause burns on contact.
- The sauna heating unit is not intended for installation or placement in a niche under the bench or under a roof slope.
- Do not start up operation of the sauna heating unit with air intake vents closed.
- The cabin lighting with corresponding mounting must be of a type that it is splash-proof and able to withstand a surrounding temperature of 140° C. Therefore, only a VDE-certified sauna lamp of 40 W maximum may be installed for use with the sauna oven.
-  The sauna system (sauna heating unit, control unit and lighting etc.) may be hard-wired to the power source only by a locally certified electrician. All connecting lines laid on the inside of the cabin must be made of silicone and be able to withstand a surrounding temperature of at least 170°C. If single-wired cables are used as connecting lines, they must be protected by flexible metal tubing. The minimum diameter of the connecting line and the suitable cabin size in proportion to the power supply capacity are listed

in the table.

- During the installation of the sauna heating unit, make certain that the vertical clearance between the upper edge of the sauna heating unit and the sauna ceiling is sufficient . The horizontal (lateral) clearance between the sauna heating unit and the cabin wall is provided in the dimension diagram of the respective sauna heating unit. The required distance between the lower edge of the sauna heating unit and the floor is also provided by the dimension diagram. In case of floor-standing ovens, the distance is determined by the base.
- Fundamentally, it is important to make sure that the sauna heating unit is not placed on a floor that consists of an easily flammable material (wood, synthetic flooring or similar material). Ceramic tiles or similar materials are practical in the area of the sauna.
- Underfloor heating in a sauna leads to increased surface temperature of the floor.
- The distance between the oven safety grid or recliner bench and other flammable materials and the sauna heating unit are provided in the dimensional data of the respective sauna heating unit. The safety grid height must be approximately equal to the frontal height of the sauna heating unit.
-  By cleaning of parts with sharp edges or corners the appropriate personal protection measures against potential injuries should be taken.
- The sauna heaters should be secured against overturning during installation on site.

Electrical connection

Your electrician will be able to accomplish this work without further explanation in accordance with the provided wiring schematic and with the help of the circuit diagram mounted inside the respective control unit.

Be sure to note, however, that live wires should not be visibly laid onto the inner cabin walls due to safety considerations. For this reason, the wall element with the air intake vent is already equipped with cable conduits in most sauna cabins

Should there be no cable conduits in your cabin, drill an hole in the cabin wall immediately adjacent to the sauna heating unit where the cable projects from the sauna heating unit and pull the cable through this hole towards the exterior and then to the control unit. The cable as well as all other connecting lines (supply wire to the power source and to the cabin lighting) on the outside wall of the cabin should also be protected from damage, for ex. by installation in cable conduits or by covering with wooden skirting strips.

The sauna heater, if used with remote control*, may be used only in combination with the appropriate cover protection system or S-Guard system.

**Remote control – means settings, switching, control and adjustment of the sauna control unit by means of commands transmitted from a remote location beyond sight distance using telecommunication, wire- or wireless signal transmission systems, network and similar systems.*

Attention!

Dear customer,

according to the valid regulations, the electrical connection of the sauna heater and the control box has to be carried out through the specialist of an authorized electric shop.

We would like to mention to the fact that in case of a warranty claim, you are kindly requested to present a copy of the invoice of the executive electric shop.

**Caution!**

Different heating reaction for sauna heater with a larger quantity of stones!

Please note that a considerable amount of energy is required to heat the large quantity of stones and that a relatively low convection takes place due to the construction.

In comparison to standard saunas, this means that the cabin requires a longer period to heat up and that it stays hot for a long time after the end of the operating time.

Measures for improved air circulation in the sauna cabin may be necessary (forced ventilation).

When adding an infusion, please be aware that hot steam can also escape at the bottom through the open mesh of the side parts. Therefore please maintain a sufficient clearance! Danger of scalding!!

Technical data

Heater power acc. to DIN	Electr. connection	Control unit fuse in A	Fuses in the PCU in A	Connection mains - control unit	Connection mains - PCU	Connection control unit - heater	Connection PCU - heater	Connection control unit - PCU	Power control unit (PCU) required
9 kW	400 V 3 N AC 50 Hz	3 x 16				5 x 1,5 ²			
12 kW			3 x 16	5 x 2,5 ²	5 x 2,5 ²		5 x 1,5 ²	4 x 1,5 ²	EMOTEC L09
15 kW									
18 kW									

All information on cable diameters are minimum diameters in mm² copper line.

Outer coating	Installation dimensions in cm HWD	For cabin volume	Minimum dimension for ventilation and bleeding	Weight without stones and packaging	Stone filling	Power control unit (PCU) required	to be used with the control units
Expanded metal with wide bar mesh	100 x 41 x 41	9-14 m ³	300 cm ²	Approx. 35kg	Approx. 125kg		EMOTEC DC 9000 EMOTEC DC 9000 DB/ DL/DLF EMOTEC HCS 9003 EMOTEC HCS 9003 DB/ DL/DLF EmoTouch II PB/AF/GF
		14 18 m ³				EMOTEC L09	
		18 - 25 m ³					
		24 - 30 m ³					

Wiring diagram for sauna heaters

9 kW

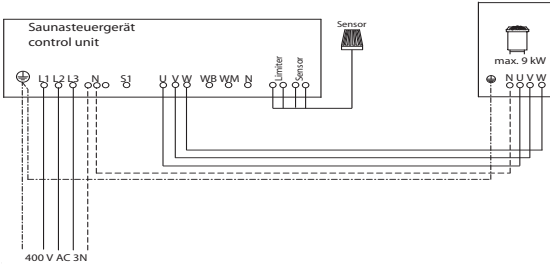

12-18 kW

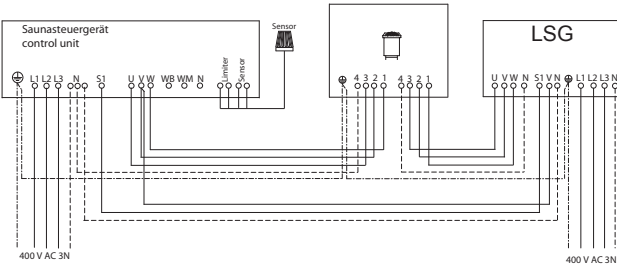

Detailed wiring diagram for sauna heaters

9 kW

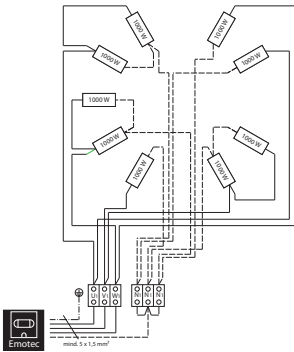

12 kW

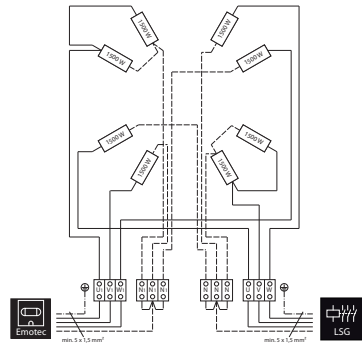

15 kW

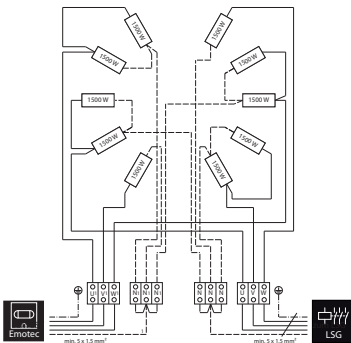

18 kW

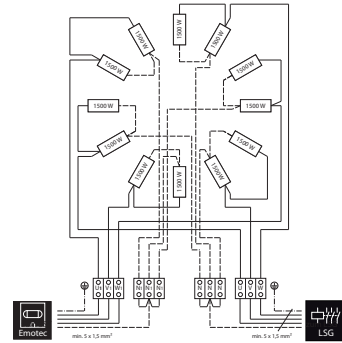

Assembly

Minimum clearances

The sauna cabin interior must be at least 2.10 m in height.

When assembling the sauna heater, make sure that the vertical clearance between the upper edge of the sauna heater and the sauna ceiling is at least 110 cm and the horizontal (side) clearance between the heater and cabin wall or other flammable material is at least 20 cm (9 kW 12 cm) (fig. 1).

- Pay attention to the minimum clearances in the following diagrams!
- Due to the height of the heater, the top oven protection grate must not correspond with the height of the heater, but be mounted at a height of approx. 85 cm.

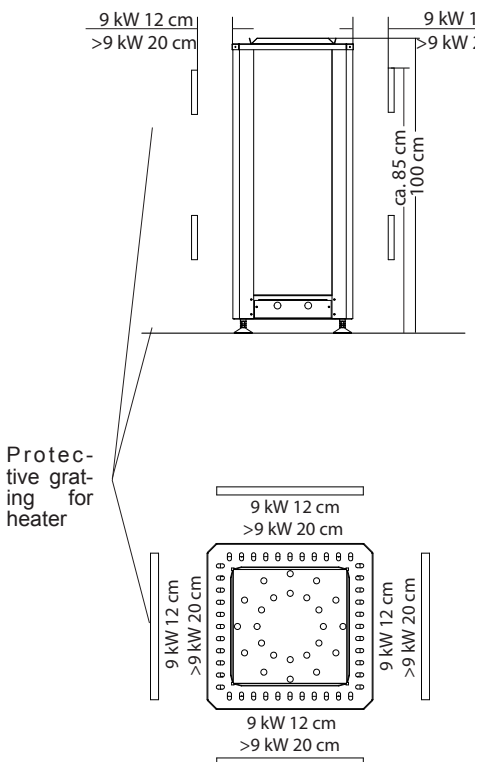

Fig. 1

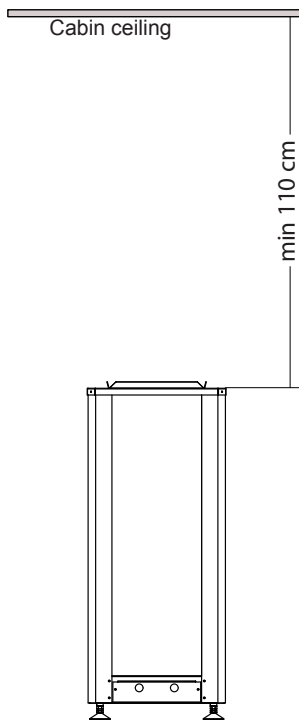

Fig. 2

Electrical connection

The sauna heater is designed for a connection voltage of 400 V 3N AC.

The sauna heaters must be operated using suitable sauna control units with additional power control units.

Saunadome heaters are generally wired in 2 circuits.

The connection box is found behind the exterior cladding.

Leakage current: max. 0.75 mA per kW of heating power

Sauna heater for use in commercial saunas.

Sauna stones

Sauna stones are a natural product. Always check the sauna stones at regular intervals. Sauna stones can be particularly attacked by strong infusion concentrations and will be corroded over the course of time. Please ask your sauna supplier.

Thoroughly wash the supplied sauna stones under running water and insert them in the stone holder so that the heating rods can be seen from the outside.

The quantity of infusion stones allows an intensive infusion.

Due to the large quantity of stones, the first infusion should be added one hour after starting heating at the earliest.

Check the quantity of stones at regular intervals and remove any small particles of stone lying in the expanded metal mesh.

Never add more infusion quantities or essential oils than stated on the container. Never use alcohol or diluted concentrations. Caution! Risk of fire.

Caution!

The filled heater has a weight of approximately 150 kg.



Do not tip the heater using the adjustment feet or move it when filled. There is the risk of the adjustment feet being damaged.

Right



The heating rods are fully covered by stones. The heating rods cannot be seen from the outside.

Wrong

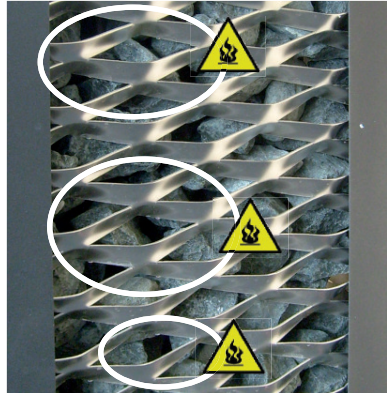

Heating rods can be seen between the stones.

A visible heating rod can even pose a risk to flammable materials beyond the safety clearance.

Make sure that no heating rods can be seen from outside between the stones.

Risk of fire!!!

Maintenance and care

All sauna heaters are made of a corrosion-resistant material. You should maintain and care for the device so that you can enjoy your sauna heater for a long time. You must make sure that all openings and radiation plates in the vacuum area are kept free of obstructions. By drawing in fresh air, these can easily become blocked with fluff and dust. This restricts the air convection of the sauna heater and unauthorized temperatures can occur.

Clean or remove limescale from the device as required. Please contact your sauna dealer or the manufacturing factory if you notice any defects or signs of wear and tear.

If you haven't used your sauna for a while, make sure that no hand towels, detergents or other objects have been placed on the sauna heater or evaporator before starting the sauna.



Suitable protective gloves must be worn when cleaning the outer coating parts of blades.

DIN VDE part 703 must be observed for installation of the sauna heaters!

This norm, in the latest version valid since February 2006 with amendments to paragraph 703.412.05, makes the following statement; quote:

The additional protection must be provided for all of the sauna's electrical circuits through one or more residual current devices (RCD) with a differential measurement current no higher than 30 mA, with the exception of sauna heaters.

EN 60335-1 DIN VDE part 1 from January 2001 states the following under paragraph 13: quote:

The leakage current may not exceed the following values at operating temperature:

- *For fixed heaters under protection class I: 0.75 mA or 0.75 mA per kW measurement detection of the device, depending on which value is higher, with a maximum value of 5 mA.*

If a residual current device (RCD) is installed, make sure that no other electrical consumers are protected using this RCD.

According to the current status of technology, it does not make sense to use vapor-tight heaters in saunas. In some cases, the magnesium-oxide filling in the heaters by draw moisture from the air through the vapor-diffusion silicone seal which may lead to the RCD triggering in a few cases. This is a physical process and is not a manufacturing error.

In this case, the heater must be heated by a specialist under supervision, whereby the function of the RCD is by-passed. After the moisture has been drawn from the heating rods after approx. 10 mins, the RCD can be incorporated in the electrical circuit again!

If the sauna is not used very often, we recommend heating it approximately every six weeks so that moisture does not accumulate in the heating rods.

If the RCD is triggered during initialization, the electrical installation must be checked once again.

The electrical fitter is responsible for correct connection of the heaters and liability by the manufacturer is therefore excluded!

Please keep this address in a safe place together with the installation guide.

To help us answer your questions quickly and competently please provide the information printed on the type shield including the model, item no. and serial no., in all inquiries.

Service Address:

EOS Saunatechnik GmbH
Adolf-Weiß-Straße 43
35759 Driedorf-Mademühlen, Germany

Tel: +49 (0)2775 82-514

Fax: +49 (0)2775 82-431

servicecenter@eos-sauna.de
www.eos-sauna.de

WARRANTY

The warranty is provided according to the legal regulations at present.

Manufacturer's guarantee:

- The period of guarantee starts from the date of purchase and lasts up to 2 years by commercial use and 3 years by private use.
- Always include the completed guarantee certificate when returning equipment.
- The guarantee is void for appliances which have been modified without manufacturer's explicit agreement.
- Damages caused by incorrect operation or handling through non-authorized persons are not covered under the terms of guarantee.
- In the event of a claim please indicate the serial number as well as the item number and model name with detailed description of the fault.
- This guarantee covers defective parts and labour but not the defects caused by wear and tear.

In case of complaint please return the equipment in its original packaging or other suitable packaging (caution: danger of transport damage) to our service department.

Always include the completed warranty certificate when returning equipment.

Possible shipping costs arising from the transport to and from point of repair cannot be overtaken by us.

Outside of Germany please contact your specialist dealer in case of warranty claims. Direct warranty processing with our service department is in this case not possible.

Equipment commissioning date:

Stamp and signature of the authorized electrician:

Handling procedures for return shipments (RMA) - Details for all returns !

Dear customer

we hope that you will rejoice in the ordered articles. Just in case that you are not entirely contented as an exception, please follow the procedures specified below. This enabling us to ensure a quick and smooth handling of the return shipment.

Please absolutely respect for all returns!

- Please add the available **RMA-voucher** always **completely filled out** together with an **invoice copy** to the return shipment! Do not stick it on the goods or on the packaging. **We do not accept the return shipment without these papers.**
- Not prepaid parcels **will be refused** and returned to Sender! Please always ask for the **RMA-No.** for the cheapest return.
- **Please pay attention that** the goods have to be sent back **without visible marks of use** in the **original scope of delivery and in original packing.**
- We recommend to use an **additional solid and break-proof covering box** which should be padded out with styrofoam, paper or similar. Transport damages as a result of faulty packing are for the sender's account.

Form of complaint:

1) Transport damage

- Please check the content of your parcel immediately and advise the forwarding company of a claim (parcel service/ freight forwarder)
- Do not use damaged goods!
- Ask the forwarder **for a written acknowledgement of the damages.**
- **Report the claim promptly by phone to your dealer.** He will discuss with you how to act in this case.
- If the transport box has been damaged, please use an additional covering box. Do not forget to add the **acknowledgement of the damage of the forwarding company !**

2) Faulty goods

- The implied warranty period is 2 years. Please contact your dealer in case of **faulty or wrong articles or missing accessories.** He will discuss with you the individual case and try for immediate and customer-friendly solution.
- For **economic returns** within Germany you will get an **RMA-number from the manufacturer.**
- All returns have to be in the **original packing of the goods with corresponding accessories.** Please repack the goods to avoid damages. In case of wrong delivery, please do not use this article !

3) Problems of installation and functioning

- Please **read the manual carefully first of all** and pay attention to the indicated assembly or installing instructions.
- **Your dealer should be the first contact person** because he knows his products best and also knows possible problems.
- **In case of function problems with an article,** please check at first whether there is an obvious material defect. The quality system in our factory reduces malfunctions of new appliances to almost zero.