

# Sauna control unit

## Pro C2 PRO-C2

INSTRUCTIONS FOR INSTALLATION AND USE  
English

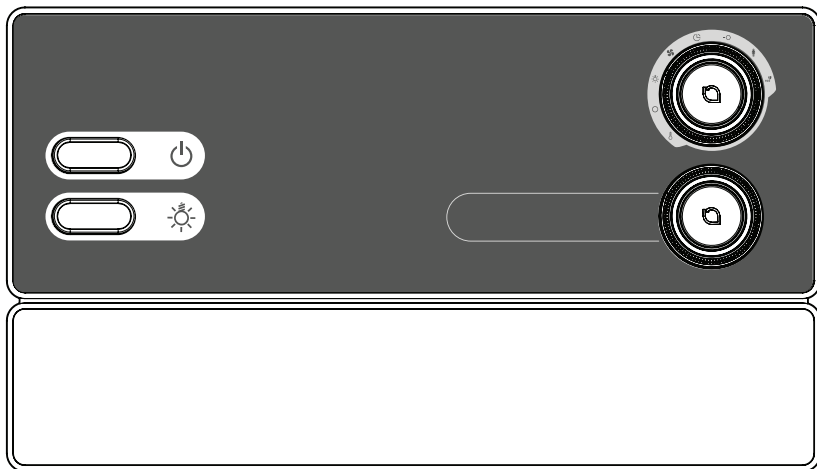

EN

# Table of Contents

<b>1. About this instruction manual</b>	<b>5</b>
<b>2. Important information for your safety</b>	<b>6</b>
2.1. Intended use	6
2.2. Safety information for the installer	6
2.3. Safety information for the user	7
<b>3. Product description</b>	<b>9</b>
3.1. Scope of delivery	9
3.2. Optional accessories	9
3.3. Product functions	9
3.4. Sensor operating modes	10
<b>4. Installation</b>	<b>12</b>
4.1. Installing the sauna control unit	12
4.2. Installing the heater sensor F1 with excess temperature fuse	14
4.3. Installing bench sensor F2 (optional)	15
4.4. Installing the foil sensor (optional)	15
<b>5. Electrical connection</b>	<b>16</b>
5.1. Connecting the power supply cable and heater cable	17
5.2. Connecting the light	17
5.3. Connecting the fan (optional)	17
5.4. Connecting the additional output (optional)	18
5.5. Connecting the power booster (optional)	18
5.6. Connecting heater sensor F1	18
5.7. Installing bench sensor F2 (optional)	18
5.8. Connecting the film sensor (optional)	19
5.9. Connecting the safety shut-off device	19
5.10. Remote start	19
5.11. Status output	20
5.12. Finishing installation	20

<b>6. Performing tests</b>	<b>21</b>
<b>7. Connection diagram</b>	<b>23</b>
<b>8. Starting up</b>	<b>24</b>
8.1. Function selection switch settings	24
8.2. Settings in the technician menu	26
<b>9. Operating elements</b>	<b>31</b>
9.1. Description of the operating elements	31
9.2. The function selector	31
9.3. The intensity selector	32
<b>10. Operation</b>	<b>33</b>
10.1. Switching on the light	33
10.2. Switching on the sauna control unit	33
10.3. Starting the sauna	34
10.4. Starting additional output	34
10.5. Switching on the light	35
10.6. Starting the fan	36
10.7. Setting the preset time	37
10.8. Cancelling the preset time function	38
10.9. Setting the duration	38
10.10. Changing the preset values	39
10.11. Switching off functions	39
10.12. Switching off the sauna control unit	39
<b>11. User program</b>	<b>40</b>
11.1. Preset user programs	40
11.2. Accessing user programs	41
11.3. Creating your own user programs	41

---

<b>12. The Eco-function</b>	<b>43</b>
<b>13. Cleaning and maintenance</b>	<b>44</b>
13.1. Cleaning.....	44
13.2. Maintenance.....	44
<b>14. Troubleshooting</b>	<b>45</b>
<b>15. Disposal</b>	<b>46</b>
<b>16. Technical data</b>	<b>47</b>

## 1. About this instruction manual

Read these instructions for installation and use carefully and keep them within reach of the sauna control unit. This ensures that you can refer to information regarding your safety and regarding operation at any time.



---

These instructions for installation and use can also be found in the downloads section of our website: [www.sentiotec.com](http://www.sentiotec.com).

---

### ***Symbols used for warning notices***

In these instructions for installation and use, a warning notice located next to an activity indicates that this activity poses a risk. Always observe the warning notices. This prevents damage to property and injuries which could in the worst case even be fatal.

The warning notices contain keywords, which have the following meanings:



#### **DANGER!**

Serious or fatal injury will occur if this warning notice is not observed.

---



#### **WARNING!**

Serious or fatal injury can occur if this warning notice is not observed.

---



#### **CAUTION!**

Minor injuries can occur if this warning notice is not observed.

---

#### **ATTENTION!**

This keyword is a warning that damage to property can occur.

---

### ***Other symbols***



This symbol indicates tips and useful information.

## **2. Important information for your safety**

The sauna control unit Pro C3 has been produced in accordance with the applicable safety regulations for technical units. However, hazards may occur during use. Therefore adhere to the following safety information and the specific warning notices in the individual chapters. Also observe the safety information for the devices connected.

### **2.1. Intended use**

The sauna control unit Pro C2 is used exclusively for operating and controlling the sauna functions in accordance with the technical data.

The sauna control unit Pro C2 may only be used for operating and controlling a sauna heater which has been certified as satisfying the combustion test described in paragraph 19.101 of EN 60335-2-53. Alternatively, a suitable safety shut-off device can be installed in or above the heater.

The sauna control unit Pro C2 may only be used for operating and controlling 3 heating circuits with a maximum heating capacity of 3.5 kW per heating circuit. The maximum additional output capacity totals 3.5 kW.

Any use exceeding this scope is considered improper use. Improper use can result in damage to the product, in severe injuries or death.

### **2.2. Safety information for the installer**

- Installation may only be performed by a qualified electrician or similarly qualified person.
- Work on the sauna control unit may only be performed when the power has been disconnected.

- A three-phase shut-off device with a 3 mm contact opening must be provided during installation. This is provided by the fuse.
- The sauna control unit must be installed outside the sauna room at a height of approx. 1.70 m or in accordance with the recommendation issued by the sauna manufacturer. The ambient temperature must be within a range spanning -10 °C to +40 °C.
- The heater sensor must be attached in a way that it is not affected by a flow of air.
- The heater supply cable must have a minimum cross-section of 2.5 mm<sup>2</sup> and be temperature resistant up to 150 °C.
- Also comply with the regulations applicable at the installation location.
- For your own safety, consult your supplier in the event of problems that are not explained in sufficient detail in the installation instructions.

### 2.3. Safety information for the user

- The sauna control unit must not be used by children under 8 years old.
- The sauna control unit may only be used by children above 8 years old, by persons with limited psychological, sensory or mental capabilities or by persons with lack of experience/knowledge:
  - When they are supervised.
  - When they have been shown how to use the device safely and are aware of the hazards that could occur.
- Children must not play with the sauna control unit.
- Children under 14 years of age may only clean the sauna control unit if they are supervised.
- For health reasons, do not use the sauna when under the influence of alcohol, medication or drugs.

- Make sure that no flammable objects have been placed on the sauna heater before the sauna control unit is switched on.
- Make sure that no flammable objects have been placed on the heater before activating the preset time function or the stand-by mode for the remote start.
- Make sure that no flammable objects have been placed on or in front of the infrared lamp before the sauna control unit is switched on.
- Make sure that no flammable objects have been placed on the heater before activating the infrared lamp or the stand-by mode for the remote start.
- For your own safety, consult your supplier in the event of problems that are not described in sufficient detail in the operating instructions.



## 3. Product description

### 3.1. Scope of delivery

- Sauna control unit
- Heater sensor with integrated excess temperature fuse (F1)
- Bench sensor (F2)
- Sensor wires
- Installation material

### 3.2. Optional accessories

- Foil sensor (item number: P-ISF-FF)
- Power booster (item number: O-S2-18/O-S2-30)
- Safety shut-off (item number: HT-SWL)

### 3.3. Product functions

The sauna control unit Pro C2 features the following functions:

- Regulation of sauna heaters with a heating output of up to 10.5 kW in the temperature range spanning 30 °C to 110 °C.
- A power booster allows the maximum contact rating to be increased from 10.5 kW to 18 kW or 30 kW.
- Optional dimming or activation of a room light (up to 100 W)
- Optional dimmer function or activation of a fan (up to 100 W)
- Optional dimmer function (up to 500 W) or activation (up to 3.5 kW) for an additional output (e.g. an infrared lamp or infrared heat plates)
- Remote start function
- Status output
- Preset time function (up to 24 hours)

- **User program**  
The user program enables favourite sauna settings to be saved and accessed again. There are 5 preset user programs available which can be modified according to user requirements.
- **Automatic heating period limiter**  
The sauna control unit shuts down automatically after the maximum heating period for safety reasons. The maximum heating period can be set to 6 h, 12 h, 18 h or 24 h.
- **Excess temperature fuse**  
The excess temperature fuse is installed in the housing for the heater sensor. Should the sauna heater continue heating after reaching the preferred temperature due to a defect, the excess temperature fuse switches the sauna heater off at a temperature of approx. 139 °C.

### **3.4. Sensor operating modes**

The sauna control unit can be operated with one or two temperature sensors.

#### ***Single-sensor mode (F1)***

Single-sensor mode must be activated in the technician menu (see **8.2. Settings in the technician menu** on page **26**).

In single-sensor mode, the sauna control unit is operated with the heater sensor with excess temperature fuse (F1) only.

In single-sensor mode, the sauna control unit only displays the set temperature as standard. The actual temperature is not displayed. Should the sauna control unit display the temperature above the heater (F1) as an actual temperature in single-sensor mode, it must be activated when starting up for the first time (see **8.2. Settings in the technician menu** on page **26**)

***Two-sensor mode with bench sensor (F2)***

In two-sensor mode with bench sensor, a second temperature sensor (bench sensor) is installed above the rear sauna bench. The sauna control unit displays the temperature measured by the bench sensor as the actual temperature.

## 4. Installation

### 4.1. Installing the sauna control unit

---

**ATTENTION!*****Damage to the unit***

The sauna control unit is protected against jets of water, however direct contact with water could still damage the unit.

- Install the sauna control unit in a dry place at which a maximum humidity of 95% is not exceeded.
- 

**ATTENTION!*****Sources of interference can have a negative effect on signal transmission***

- Lay all sensor wires separately from other mains wires and control wires.
  - Protect wires with only one layer of insulation by using a pipe (double insulation).
- 

Observe the following points when installing the sauna control unit:

- The sauna control unit must be installed outside the sauna room or in accordance with the recommendation issued by the sauna manufacturer.
- The ambient temperature must be within a range spanning -10 °C to +40 °C.
- The sensors may only be connected using the sensor wires provided with the unit, which are heat-resistant up to 150 °C.



---

The sensor wires may be extended under the following conditions:

- When a silicon wire resistant to temperatures up to 150 °C is used.
  - The minimum cross-section of the wire totals 0.75 mm<sup>2</sup>.
  - The length of the heater sensor wires may NOT exceed 10 m.
-

To install the sauna control unit, perform the following steps:

1. Screw two Phillips-head screws (16 mm) into the wall of the sauna at a height of approx. 1.70 m to a distance of up to 7 mm. The two screws must be placed at a distance of 145 mm from each other (see **Fig. 1**).

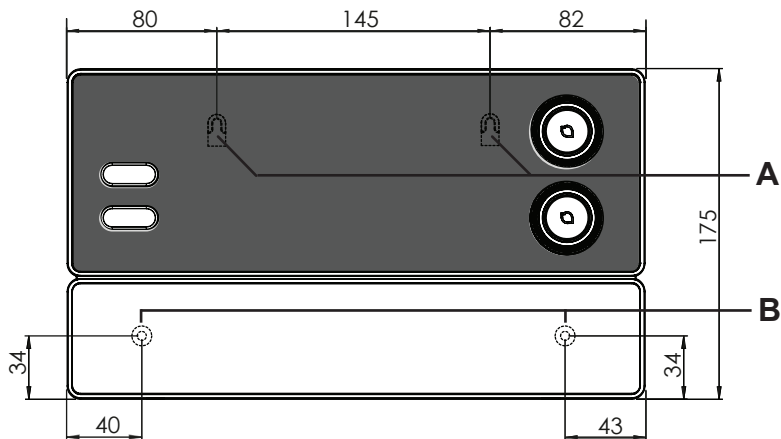

**Fig. 1** Position of the attachment device and the installation holes (dimensions in mm)

EN

2. Press the clip locks **C** in lightly using a screwdriver and remove the cover from the housing (see **Fig. 2**).
3. Fasten the sauna control unit onto the Phillips-head screws using the attachment device **A** as an aid (see **Fig. 1**).
4. Screw two Phillips-head screws (16 mm) into the lower fastening holes **B** (see **Fig. 1**).

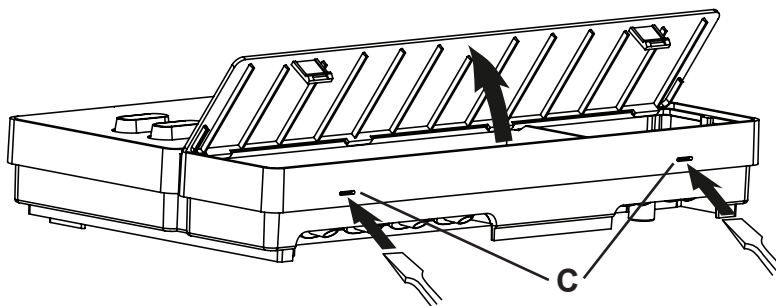

**Fig. 2** Removing the cover from the housing

## 4.2. Installing the heater sensor F1 with excess temperature fuse

Observe the following points when installing the heater sensor:

- The heater sensor must be installed on the rear of the heater, above the middle of the sauna heater. An interval of approx. 15 cm to the roof of the sauna room must be maintained.
- The heater sensor must be attached in a way that it is not affected by a flow of air.

To install the heater sensor, perform the following steps (see **Fig. 3**):

1. Lay the two 2-pin heater sensor wires in the wall of the sauna room, leading them to the heater sensor installation location and affix the heater sensor wires using wire clips.
2. Pull the two half-shells [1] of the heater sensor apart.
3. Connect the four connectors for the heater sensor wire [5] in accordance with the **Fig. 3**.
4. Place the connection panel [2] crossways (as shown in **Fig. 3**) in the heater sensor half-shells.
5. Place the two half-shells together, screw them together using the two Phillips-head screws [3] (9 mm) and check whether the heater sensor has been securely closed.
6. Install the heater sensor on the rear of the heater using the two wood screws enclosed [6] (16 mm).

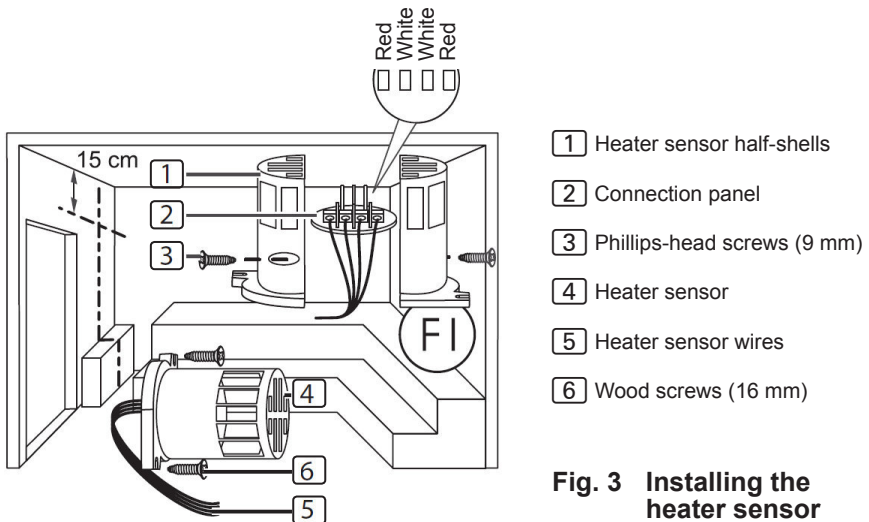

**Fig. 3** Installing the heater sensor

### 4.3. Installing bench sensor F2 (optional)

The bench sensor must be installed on the wall of the sauna room, above the rear bench seat. An interval of approx. 15 cm to the roof of the sauna room must be maintained.

To install the bench sensor, perform the following steps:

1. Lay the two 2-pin bench sensor wires in the wall of the sauna room, leading them to the bench sensor installation location and affix the bench sensor wires using wire clips.
2. Pull the two half-shells of the bench sensor apart.
3. Connect the two connectors for the bench sensor wire to the two middle terminals on the connection panel.
4. Place the connection panel crossways in the bench sensor half-shells.
5. Place the two half-shells together and screw them together using the two Phillips-head screws (9 mm).
6. Check whether the bench sensor has been securely closed.
7. Install the bench sensor on the wall of the sauna room using the two wood screws enclosed (16 mm). Maintain an interval of 15 cm to the roof of the sauna room.

### 4.4. Installing the foil sensor (optional)

If one of the following infrared heat plates is connected to an additional output, the foil sensor P-ISX-FF must be used:

- IR-WP-100
  - IR-WP-175
  - IR-WP-390
  - IR-WP-510
  - IR-WPHL-100
  - IR-WPHL-175
  - IR-WPHL-390
  - IR-WPHL-510
- When installing the foil sensor, observe the operating instructions for the infrared heat plates.
  - Use of a foil sensor must be activated in the technician menu (see **8.2. Settings in the technician menu** on page **26**).

## 5. Electrical connection

### ATTENTION!

#### *Damage to the unit*

- The sauna control unit may only be used for operating and controlling 3 heating circuits with a maximum heating capacity of 3.5 kW per heating circuit. The maximum additional output capacity totals 3.5 kW.

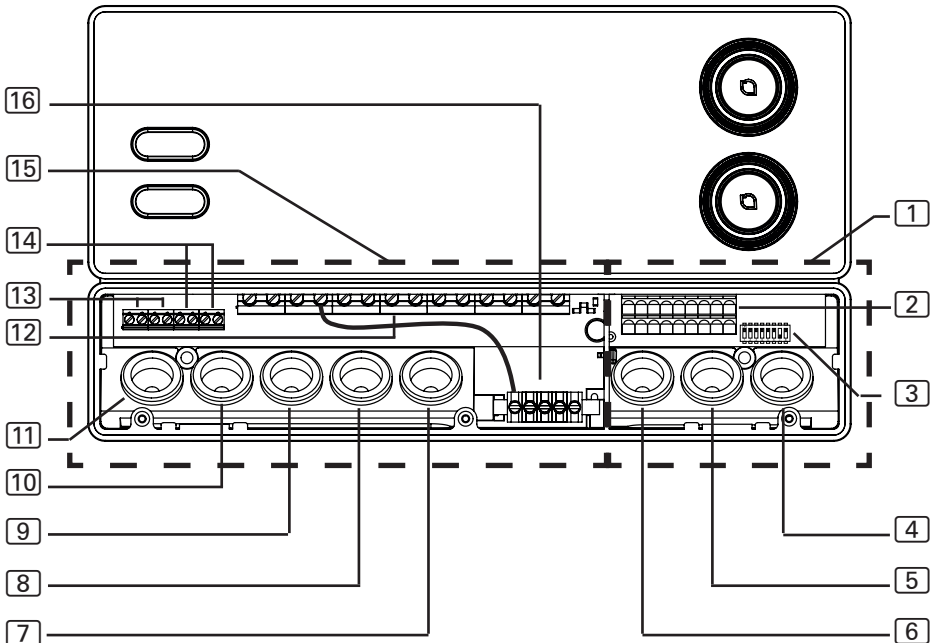

- |  |   |
|--|---|
| 1 Low-voltage connection area  | 8 Cable bushing for heater wire   |
| 2 Terminal strips for safety shut-off device, remote start, status output and sensor wires | 9 Cable bushing for power supply cable                                    |
| 3 Function selection switch  | 10 Cable bushing for power booster  |
| 4 Cable bushing for F2 and foil sensors  | 11 Cable bushing for lights and fan                                       |
| 5 Cable bushing for F1 sensor and status output  | 12 Terminal strip for heater and power supply cable and additional device |
| 6 Cable bushing for safety shut-off device and remote start                                | 13 Terminal strip for lights and fan                                      |
| 7 Cable bushing for additional output  | 14 Terminal strip for power booster                                       |
|  | 15 Connection area for 230 V / 400 V                                      |
|  | 16 Earth rail   |



Observe the following points when connecting the power to the sauna control unit:

- Installation may only be performed by a qualified electrician or similarly qualified person.



Please observe that in the event of a guarantee claim, a copy of the bill from the electrician performing the work must be presented.

- Work on the sauna control unit may only be performed when the power has been disconnected.
- There must be a fixed connection for the electrical power supply.
- A three-phase shut-off device with a 3 mm contact opening must be provided during installation. This is provided by the fuse.
- Observe the connection diagram (**Fig. 4**) on page **23**.

## 5.1. Connecting the power supply cable and heater cable

1. Guide the power supply and heater cable through the cable bushings **9** and **8** into the connection area for 230 V/400 V **15**.
2. Connect the power supply cables to the terminal strip **12** in accordance with the connection diagram. Observe the operating instructions for the respective devices.

EN

## 5.2. Connecting the light

1. Guide the light cable through the cable bushing **11** into the connection area for 230 V/400 V **15**.
2. Connect the light cable to the terminal strip **13** in accordance with the connection diagram. Observe the operating instructions for the respective device.

## 5.3. Connecting the fan (optional)

1. Guide the light cable through the cable bushing **11** into the connection area for 230 V/400 V **15**.
2. Connect the fan cable to the terminal strip **13** in accordance with the connection diagram. Observe the operating instructions for the respective device.

#### 5.4. Connecting the additional output (optional)

The additional output can, for example, be used for an infrared lamp or infrared heat plates.

1. Guide the connection cable for the additional device through the cable bushing [7] into the connection area for 230 V/400 V [15].
2. Connect the power supply cables to the terminal strip [12] in accordance with the connection diagram. Observe the operating instructions and safety instructions for the respective device.

#### 5.5. Connecting the power booster (optional)

1. Guide the cable for the power booster through the cable bushing [10] into the connection area for 230 V/400 V [16].
2. Connect the cable for the power booster to the terminal strip [14] in accordance with the connection diagram. To do so, use terminal “ST1” for the safety circuit, and terminal “ST2” for the control circuit. Observe the operating instructions for the respective device.

#### 5.6. Connecting heater sensor F1

1. Guide the wires for the heater sensor through the cable bushing [5] into the low-voltage connection area [1].
2. Connect the red wires for the heater sensor to the terminals labelled “STB” in terminal strip [2].
3. Connect the white wires for the heater sensor to the terminals labelled “F1” in terminal strip [2].

#### 5.7. Installing bench sensor F2 (optional)

1. Guide the wires for the bench sensor through the cable bushing [4] into the low-voltage connection area [1].
2. Connect the wires for the bench sensor to the terminals labelled “F2” in terminal strip [2].

## 5.8. Connecting the film sensor (optional)

1. Guide the wires for the sensor through the cable bushing [4] into the low-voltage connection area [1].
2. Connect the wires for the sensor to the terminals labelled “FF” in terminal strip [2].

## 5.9. Connecting the safety shut-off device

EN 60335-2-53 states that sauna control units with a remote start or preset timer function may only be used for operating and regulating a sauna heater which has satisfied the combustion test described in paragraph 19.101. Alternatively, a suitable safety shut-off device can be installed in or above the heater. This shuts the sauna heater off when objects, e.g. a towel, are placed on the sauna heater.

To install the safety shut-off device, perform the following steps:

1. Install the safety shut-off device in accordance with the operating instructions for the device.
2. Guide the wires for the safety shut-off device through the cable bushing [6] into the low-voltage connection area [1].
3. Connect the wires for the temperature sensor to the terminals labelled “OSG” in terminal strip [2].

EN

## 5.10. Remote start

This is connected using terminals “S”, “B” and “C”. “S” stands for sauna mode. “B” is a +24 V DC output. This must be activated using a switch or an actuator on terminal “S”.

### 5.11. Status output

Any electrical device can be connected to the status output terminal which is suitable for 24 V DC voltage and draws a current no greater than 200 mA.

Make sure the polarity is correct when connecting a device. When LEDs are used, a suitable series resistor must be used.

### 5.12. Finishing installation

1. Connect the earth conductor for the power supply cable and all devices to the earth rail **16**.
2. Place the cover of the housing on the upper edge of the junction box.
3. Push the clip locks inwards lightly, and turn the cover of the housing downwards until it engages audibly.

## 6. Performing tests

The following tests must be performed by a certified electrical fitter.



### **WARNING!**

***The following tests must be performed with the power supply switched on. There is a danger of electric shock.***

- NEVER touch live parts.

1. Check the contact of the earth conductors on the earth conductor terminal.
2. Check the excess temperature fuse on the heater sensor F1.
  - a. Switch on the sauna control unit.
  - b. Open the heater sensor and disconnect one of the two red wires for the heater sensor.
    - ▶ A recurring warning tone is emitted, "Err" shows in the top display, "02" shows in the bottom display.
    - ▶ The control unit switches off the heater.
  - c. Switch off the sauna control unit.
  - d. Reconnect the red wire for the heater sensor.
  - e. Now disconnect one of the white wires for the heater sensor.
  - f. Switch on the sauna control unit.
    - ▶ A recurring warning tone is emitted, "Err" shows in the top display, "04F1" shows in the bottom display.
    - ▶ The control unit switches off the heater.
  - g. Switch off the sauna control unit.
  - h. Reconnect the white wire for the heater sensor.
3. Check the phase circuit for sauna mode L1, L2, L3 is connected to U, V, W.
4. Ensure the phase circuit for L3 is connected to W1 when the device connected to the additional output is activated.

5. Check the maximum permissible heating output of 3.5 kW per phase on the sauna control unit.
6. When there is an optional power booster:
  - a. Check the control wires ST1, ST2 and ST3.
  - b. Check the maximum permissible heating output of 3 kW per phase on the power booster S2-18.
  - c. Check the maximum permissible heating output of 7 kW per phase on the power booster S2-18.

**Fig. 4 Connection diagram**

**7. Connection diagram**

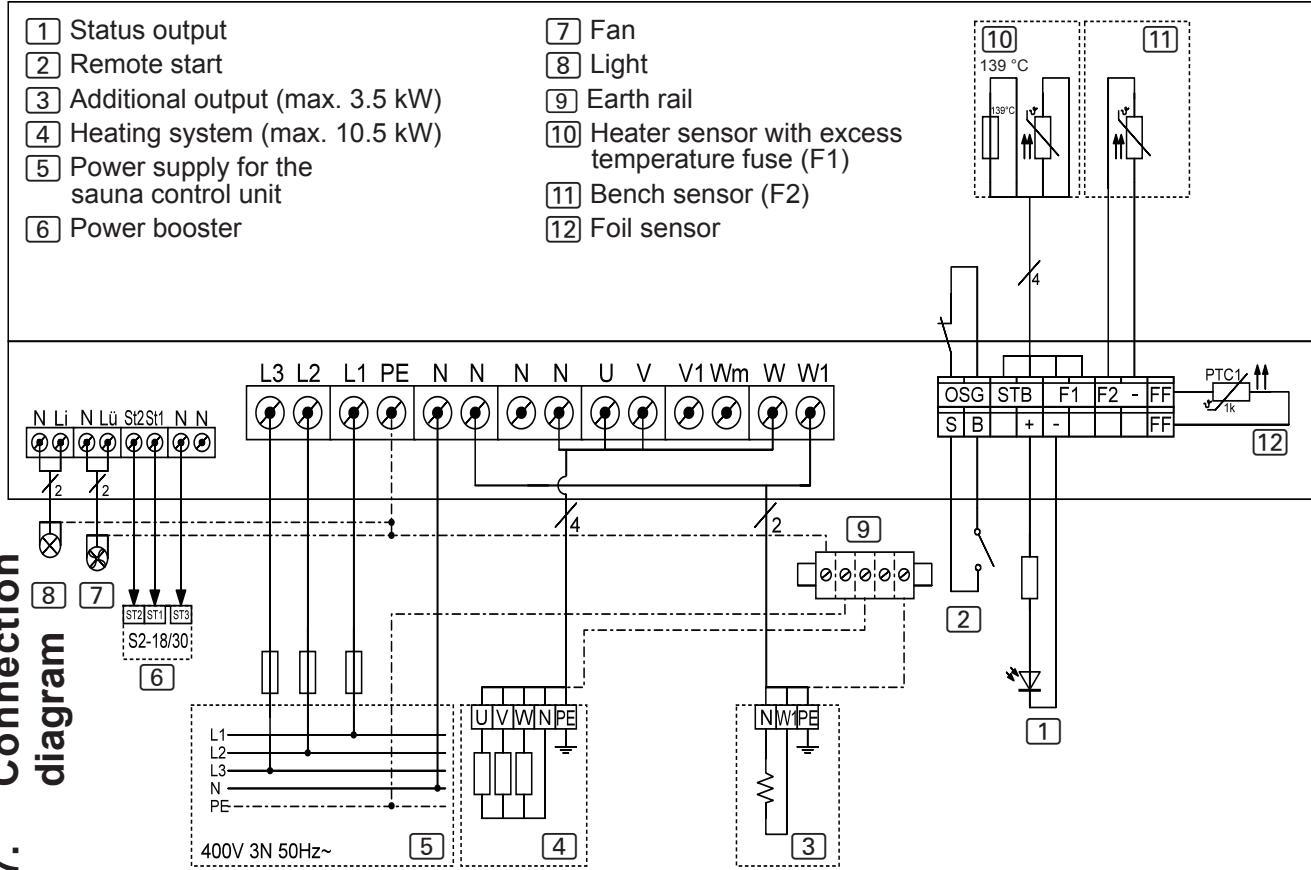

- 1 Status output
- 2 Remote start
- 3 Additional output (max. 3.5 kW)
- 4 Heating system (max. 10.5 kW)
- 5 Power supply for the sauna control unit
- 6 Power booster

- 7 Fan
- 8 Light
- 9 Earth rail
- 10 Heater sensor with excess temperature fuse (F1)
- 11 Bench sensor (F2)
- 12 Foil sensor

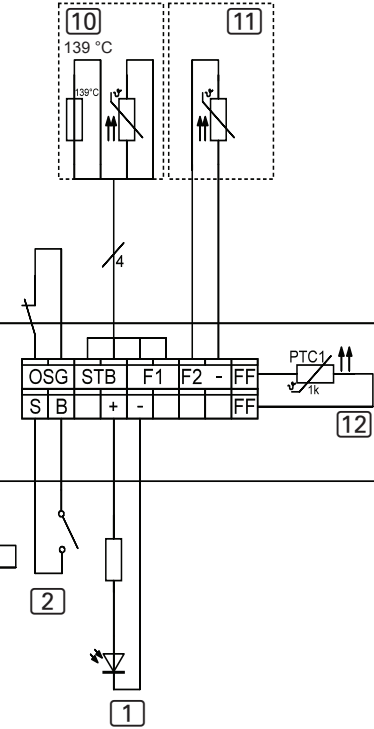
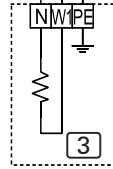
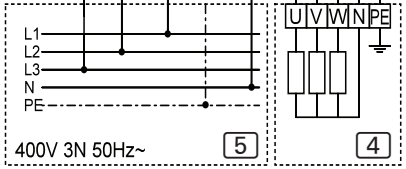

## 8. Starting up

### 8.1. Function selection switch settings

The function selection switch in the low-voltage connection area allows a variety of product functions to be activated. The figure at the right shows the standard setting for the function selection switch.

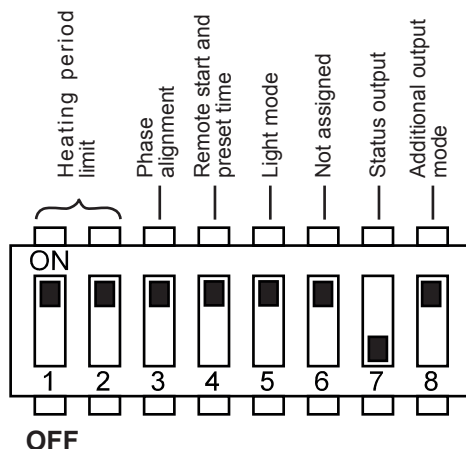

**Fig. 5** Function selection switch - Standard setting

#### Setting the heating period limit

The maximum heating period is set to 6 hours as standard. The sauna control unit shuts down automatically after the maximum heating period for safety reasons.

The function selection switch in the low-voltage connection area allows the maximum heating period to be set to 12 hours, 18 hours or 24 hours. The required positions of the function selection switch can be found in the table on the right.

Function selection switch	1	2
6 hours	ON	ON
12 hours	OFF	ON
18 hours	ON	OFF
24 hours	OFF	OFF



The EN 60335-2-53 specifies a maximum heating period limit of 6 hours for private saunas. For saunas in hotels, apartment blocks and similar locations, a maximum heating period limit of 12 hours is permissible. Extending the heating period limit to 18 hours or 24 hours is only permitted in public saunas.



### ***Activating/deactivating phase alignment***

Phase alignment is activated or deactivated using the function selection switch **3**.

- The function selection switch **3** is set to the ON position as standard. Phase alignment is therefore activated.
- If you wish to deactivate phase alignment, place the function selection switch **3** in the OFF position.

### ***Activating/deactivating the remote start and preset time function***

The remote start and preset time functions are activated or deactivated using the function selection switch **4**. The remote start and preset time functions can only be activated and deactivated together.

- The function selection switch **4** is set to the ON position as standard. The remote start and preset time functions are then activated.
- If you wish to deactivate the remote start and preset time functions, place the function selection switch **4** in the OFF position.

### ***Setting the light operating mode***



EN 60335-2-53 states that sauna control units with a remote start and preset time function may only be used with sauna heaters which satisfy the combustion test described in paragraph 19.101 of EN 60335-2-53. Alternatively, a suitable safety shut-off device can be installed in or above the heater. Observe the information in the operating instructions for your sauna heater.

EN

The light for the sauna room can either be dimmed or switched on and off. The dimmer switch function is activated or deactivated using the function selection switch **5**.

- The function selection switch **5** is set to the ON position as standard. The dimmer switch function is therefore activated.
- If you wish to deactivate the dimmer function for the sauna room light, place the function selection switch **5** in the OFF position.

### **Status output**

The remote start function is activated or deactivated using the function selection switch 7.

- The function selection switch 4 is set to the OFF position as standard. The status output is therefore activated.
- If you wish to activate the foil sensor, place the function selection switch 7 in the OFF position.

### **Setting the operating mode for the additional output**

The additional output can either be regulated or switched on and off. The dimmer switch function is activated or deactivated using the function selection switch 8.

- The function selection switch 8 is set to the ON position as standard. The dimmer switch function is therefore activated.
- If you wish to deactivate the dimmer switch for the additional output, place the function selection switch 8 in the OFF position.

## **8.2. Settings in the technician menu**

### **Opening the technician menu**

Additional settings can be made in the technician menu. To access the technician menu, perform the following steps:

1. Switch off the sauna control unit.
2. Press the bottom knob and the ON/OFF switch at the same time.
  - ▶ In the top display, "SEtt" appears briefly.
  - ▶ The two knobs flash.



---

You do NOT have to confirm the settings in the technician menu. The settings are saved automatically as soon as you close the technician menu (see page 32).

---

### **Activating single-sensor mode**

In single-sensor mode, the sauna control unit is operated with the heater sensor with an excess temperature fuse (F1) only. The two-sensor mode is activated as standard. If you wish to activate the single-sensor mode, perform the following steps:

1. Open the technician menu (see **26**).
2. Turn the bottom knob to the temperature symbol (position **A** – see point **9.2** on page **31**).
  - ▶ The temperature symbol flashes.
  - ▶ In the top display, “SEnB” appears.
  - ▶ In the bottom display, “On” appears.  
 (“On” means that the two-sensor mode is activated.)
3. Turn the bottom knob to the left.
  - ▶ In the bottom display, “OFF” appears.
  - ▶ The single-sensor mode is activated.

### **Displaying the heater temperature in single-sensor mode**

In single-sensor mode, the sauna control unit only displays the set temperature as standard. The actual temperature is not displayed. Should the sauna control unit display the temperature above the heater (F1) as an actual temperature in single-sensor mode, it must be activated in the technician menu.

EN

1. Open the technician menu (see page **26**).
2. Activate the single-sensor mode (see page **27**).
  - ▶ The top display shows “SEnB”.
  - ▶ The bottom display shows “OFF”.
3. Press the bottom knob.
  - ▶ In the top display, “dISP” appears.
  - ▶ In the bottom display, “SEt” appears.  
 (“SEt” means that only the set temperature is displayed in single-sensor mode.)
4. Turn the bottom knob to the left.
  - ▶ In the bottom display, “SEnS” appears.
  - ▶ The heater temperature (F1) is displayed as the actual temperature in the single-sensor mode.

***Decreasing the maximum temperature to 105 °C***

The preset temperature can be set to between 30 °C and 110 °C as standard. If you wish to decrease the maximum temperature from 110 °C to 105 °C, perform the following steps:

1. Open the technician menu (see **26**).
2. Turn the top knob to the temperature symbol (position **A** – see point **9.2** on page **31**).
  - ▶ The temperature symbol flashes.
  - ▶ In the top display, “SEnB” appears.
3. Press the bottom knob once or twice until “t HI” appears in the top display.
  - ▶ In the bottom display, “110” appears.
4. Turn the bottom knob to the left.
  - ▶ In the bottom display, “105” appears.
  - ▶ The maximum temperature was decreased from 110 °C to 105 °C.

***Setting the parameters of the PI controller***

The time constant of the PI controller (I-component) is set to 350 as standard. If you wish to change this value, perform the following steps:

1. Open the technician menu (see **26**).
2. Turn the bottom knob to the temperature symbol (position **A** – see point **9.2** on page **31**).
  - ▶ The temperature symbol flashes.
  - ▶ In the top display, “SEnB” appears.
3. Press the bottom knob several times until “PItn” appears in the top display.
4. Turn the bottom knob to the left or right to decrease or increase the time constant of the PI controller.

The direct gain of the PI controller (P-component) is set to 60 as standard. If you wish to change this value, perform the following steps:

1. Open the technician menu (see **26**).
2. Turn the bottom knob to the temperature symbol (position **A** – see point **9.2** on page **31**).
  - ▶ The temperature symbol flashes.
  - ▶ In the top display, “SEnB” appears.
3. Press the bottom knob several times until “PI P” appears in the top display.
4. Turn the bottom knob to the left or right to decrease or increase the direct gain of the PI controller.

### ***Activating/deactivating the foil sensor***

If an infrared heat plate is connected to an additional output, the P-ISX-FF foil sensor must be used. The foil sensor must be activated. Perform the following steps:

1. Open the technician menu (see **26**).
2. Turn the bottom knob to the additional output symbol (position **C** – see point **9.2** on page **31**).
  - ▶ The additional output symbol lights up.
  - ▶ In the top display, “SEnF” appears.
  - ▶ In the bottom display, “OFF” appears.  
(“OFF” means that the foil sensor is deactivated.)
3. Turn the bottom knob to the right.
  - ▶ In the bottom display, “On” appears.
  - ▶ The foil sensor is activated.

**Setting the fan operating mode**

The fan can either be regulated or switched on and off. The dimmer switch function for the fan is activated as standard. If you wish to deactivate the dimmer switch function for the fan, perform the following steps:

1. Open the technician menu (see **26**).
2. Turn the top knob to the fan symbol (position **E** – see point **9.2** on page **31**).
  - ▶ The fan symbol lights up.
  - ▶ In the top display, “FAn” appears.
  - ▶ In the bottom display, “On” appears.  
(“On” means that the dimmer switch function is activated.)
3. Turn the bottom knob to the left.
  - ▶ In the bottom display, “OFF” appears.
  - ▶ The dimmer switch function for the fan is deactivated.

**Exiting the technician menu**

- Press the bottom knob for one second.
  - ▶ The bottom knob stops flashing.
  - ▶ The top knob lights up.
  - ▶ The technician menu closes.
  - ▶ Your settings were saved.

## 9. Operating elements

### 9.1. Description of the operating elements

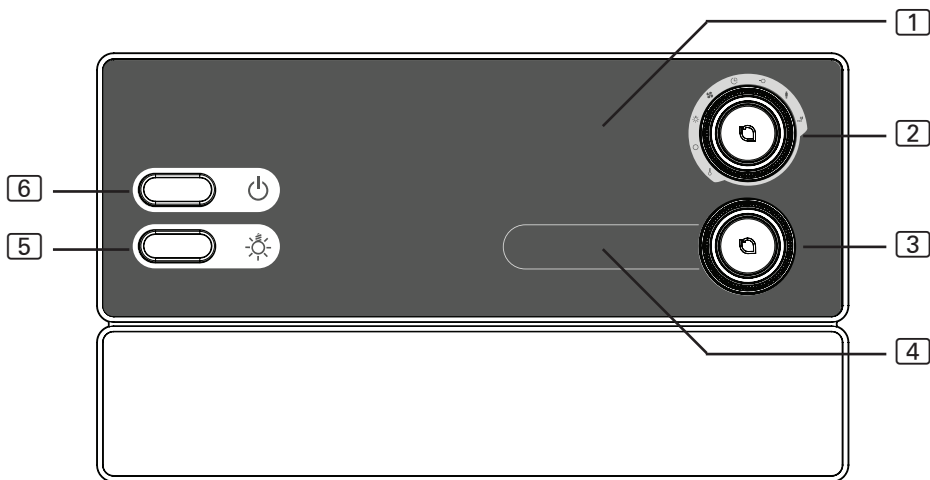

1 Additional display

2 Function selector

3 Intensity selector

4 Intensity display

5 Light switch

6 ON/OFF switch

EN

### 9.2. The function selector

The function selector 2 allows you to define which function needs to be changed with the intensity selector 3. The function selector 2 lights up when the sauna control unit is switched on.

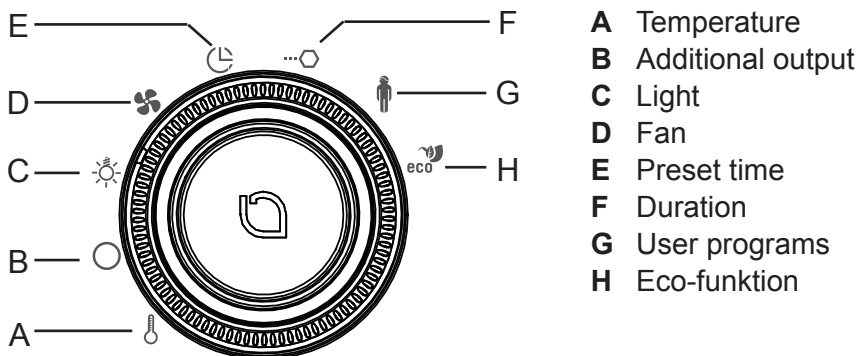

A Temperature

B Additional output

C Light

D Fan

E Preset time

F Duration

G User programs

H Eco-funktion

### 9.3. The intensity selector

The intensity selector [3] allows you to adjust the intensity or output of each function which is selected on the function selector [2].

- Turn the intensity selector [3] to the right to increase the output.
- Turn the intensity selector [3] to the left to decrease the output.

When you press the intensity selector [3], you start the function which is selected on the function selector [2].

- The intensity selector [3] lights up when the function selected on the function selector [2] is switched on.



## 10. Operation

### 10.1. Switching on the light

The light in the sauna room can be switched on and off independently of the ON/OFF switch [6].

- To switch the light on or off on the power unit, press the light switch [5].



If the light switch [5] is switched on, the sauna room light will operate at full power. If you wish to dim the light above the intensity selector [3], switch off the light switch [5].

### 10.2. Switching on the sauna control unit



#### **WARNING!**

#### ***Risk of fire***

Flammable objects that are placed on the sauna heater could ignite and cause fires.

- NEVER place flammable objects on the sauna heater.
- Make sure that NO flammable objects have been placed on the sauna heater before the sauna control unit is switched on.





- Press the ON/OFF switch [6], to switch on the sauna control unit.
  - ▶ The function selection switch [2] lights up.



#### **Basic operation**

1. Turn the function selector [2] to the function (Sauna, Light, Fan, Additional output) you wish to start.
2. Select the intensity of the function with the intensity selector [3].
3. Press the intensity selector [3] to start the function.

### 10.3. Starting the sauna

1. Turn the function selector  to position **A** (temperature).
  - ▶ The temperature symbol lights up.
2. Use the intensity selector  to set the preferred temperature.
3. Press the intensity selector .
  - ▶ The sauna heater is switched on and begins to heat up.
  - ▶ The intensity selector  lights up.
  - ▶ Then the current temperature in the sauna room is displayed in the intensity display . In single-sensor mode, the preset temperature is displayed.

### 10.4. Starting additional output

Infrared lamps, or infrared heat plates, for example, can be connected to the additional output on the sauna control unit.



#### **WARNING!**

#### ***Risk of fire***

Flammable objects that are placed on or in front of the infrared lamp could ignite and cause fires.

- NEVER place flammable objects on or in front of the infrared lamp.
- Make sure that NO flammable objects have been placed on or in front of the infrared lamp before you switch it on.

#### ***When the dimmer switch function is activated***

When the dimmer switch function for the additional output is activated, the power for the additional device can be set to a scale of 0 to 7. At 0, the additional device is switched off. 7 corresponds to full power.

1. Turn the function selector **[2]** to position **B** (additional output).
  - ▶ The additional output symbol lights up.
2. Use the intensity selector **[3]** to set the preferred power of the additional device.
3. Press the intensity selector **[3]**.
  - ▶ The additional device switches on.
  - ▶ The intensity selector **[3]** lights up.

### ***When the dimmer switch function is deactivated***

When the dimmer switch function for the additional output has been deactivated, you can only switch the additional device on and off. The device will always operate at full power.

1. Turn the function selector **[2]** to position **B** (additional output).
  - ▶ The additional output symbol lights up.
  - ▶ In the intensity display, "OFF" appears.
2. Press the intensity selector **[3]**.
  - ▶ The additional device switches on.
  - ▶ The intensity selector **[3]** lights up.
  - ▶ In the intensity display, "ON" appears.

EN

## **10.5. Switching on the light**

### ***When the dimmer switch function is activated***

When the dimmer function for the light is activated, the power for the light can be set to any level between level 0 and 100. At 0, the light is switched off. 100 corresponds to full power.



---

If the light switch **[5]** is switched on, the sauna room light will operate at full power. If you wish to dim the light above the intensity selector **[3]**, switch off the light switch **[5]**.

---

1. Turn the function selector **[2]** to position **C** (light).
  - ▶ The light symbol lights up.
2. Use the intensity selector **[3]** to set the preferred light power.
3. Press the intensity selector **[3]**.
  - ▶ The light switches on.
  - ▶ The intensity selector **[3]** lights up.

### ***When the dimmer switch function is deactivated***

When the dimmer function for the light has been deactivated, you can only switch the light on and off. The light will always operate at full power.

1. Turn the function selector **[2]** to position **C** (light).
  - ▶ The light symbol lights up.
  - ▶ In the intensity display, “OFF” appears.
2. Press the intensity selector **[3]**.
  - ▶ The light switches on.
  - ▶ The intensity selector **[3]** lights up.
  - ▶ In the intensity display, “ON” appears.

## **10.6. Starting the fan**



### ***When the dimmer switch function is activated***

When the dimmer switch function for the light is activated, the power for the fan can be set to a scale of 0 to 100. At 0, the fan is switched off. 100 corresponds to full power.

1. Turn the function selector **[2]** to position **D** (fan).
  - ▶ The fan symbol lights up.
2. Use the intensity selector **[3]** to set the preferred power of the fan.
3. Press the intensity selector **[3]**.
  - ▶ The fan switches on.
  - ▶ The intensity selector **[3]** lights up.

**When the dimmer switch function is deactivated**

When the dimmer switch function for the fan has been deactivated, you can only switch the fan on and off. The device will always operate at full power.

1. Turn the function selector  to position **D** (fan).
  - ▶ The fan symbol lights up.
  - ▶ In the intensity display, "OFF" appears.
2. Press the intensity selector .
  - ▶ The fan switches on.
  - ▶ The intensity selector  lights up.
  - ▶ In the intensity display, "ON" appears.

**10.7. Setting the preset time**



You can set the preset time to the minute. The maximum preset time totals 24 hours. The preset time is shown in hours and minutes, e.g. 8 hours and 15 minutes is shown as 8.15.

**WARNING!*****Risk of fire***

Flammable objects that are placed on the heater will ignite and cause fires.

- NEVER place flammable objects on the sauna heater.
- Make sure that NO flammable objects have been placed on the sauna heater before you activate the preset timer function.

EN

1. Start the function that is to be started after the preset time.
2. Turn the function selector  to position **E** (preset time).
  - ▶ The most recently set preset time is shown in the intensity display .
3. Use the intensity selector  to set the preferred preset time.

4. Press the intensity selector **3**.
  - ▶ The sauna control unit changes to standby mode and the timer starts running.
  - ▶ The remaining preset time is shown in the intensity display **4**.
  - ▶ The preset time symbol flashes.
  - ▶ The intensity selector **3** lights up.
  - ▶ Once the preset time has elapsed, the selected functions are started.



---

If you want to set long preset times, use the quick preset function:

- Press the intensity selector **3** and turn it at the same time.
    - ▶ The preset time changes in steps of one hour.
- 

## 10.8. Cancelling the preset time function

- Press the intensity selector **3** to cancel the preset time function.
  - ▶ The preset time countdown is cancelled.
  - ▶ The preset time symbol lights up and stays lit.

## 10.9. Setting the duration

When you start the sauna, you can already determine how long the sauna is to operate. In this case, the maximum heating time cannot be exceeded (e.g. 6 h for private saunas). The duration is shown in hours and minutes, e.g. 3 hours and 15 minutes is shown as 3.15.

1. Turn the function selector **2** to position **F** (duration).
  - ▶ The most recently set duration is shown in the intensity display **4**.
2. Use the intensity selector **3** to set the preferred duration.



---

If you want to set long durations, use the quick preset function:

- Press the intensity selector **3** and turn it at the same time.
    - ▶ The duration changes in steps of one hour.
-

## 10.10. Changing the preset values

You can change the preset values at any time during operation.

1. Turn the function selector [2] to the function you want to change.
2. Use the intensity selector [3] to set the preferred preset value.

## 10.11. Switching off functions

You can switch off each function individually.

1. Turn the function selector [2] to the function you want to switch off.
  - ▶ The intensity selector [3] lights up.
2. Press the intensity selector [3].
  - ▶ This respective device is switched off.
  - ▶ The light on the intensity selector [3] goes out.

## 10.12. Switching off the sauna control unit

- Press the ON/OFF switch [6], to switch off the sauna control unit.
  - ▶ The lights go out on the function selector [2], on the intensity selector and on the intensity level indicator.
  - ▶ The sauna control unit is switched off.

## 11. User program

The user program enables favourite sauna settings to be saved and accessed again. There are 5 preset user programs available which can be modified according to user requirements.

The settings of the following functions are stored in the user programs:

- Temperature
- Additional output, e.g. infrared lamps or infrared heat plates
- Light
- Fan

### 11.1. Preset user programs

The following user programs are already predefined.

<i>User program</i>	<i>Temperature °C</i>	<i>Additional output</i>	<i>Light %</i>	<i>Fan %</i>
1	70	0	50	0
2	90	0	50	0
3	100	0	50	0
4	0	4	50	0
5	0	7	50	0



## 11.2. Accessing user programs

1. Turn the function selector **[2]** to position **G** (user programs).
  - ▶ The user symbol lights up.
2. Use the intensity selector **[3]** to select a user program (1–5).
3. Press the intensity selector **[3]**.
  - ▶ The user program is started.
  - ▶ The intensity selector **[3]** lights up.

## 11.3. Creating your own user programs

You can create user programs as you would like. A preset user program is overwritten in the process. Perform the following steps:

1. Start all functions that are to be switched on with the user program with the preferred intensity.
2. Turn the function selector **[2]** to position **G** (user programs).
  - ▶ The user symbol lights up.
3. Use the intensity selector **[3]** to select which number (1–5) under which the new user program is to be saved.
4. Press the intensity selector **[3]** for one second.
  - ▶ The intensity selector flashes.
  - ▶ The settings are stored in the selected user program.

**Example**

<i>User program</i>	<i>Temperature °C</i>	<i>Additional output</i>	<i>Light %</i>	<i>Fan %</i>
2	80	0	50	10

Perform the following steps to save the settings in the table above in user program 2:

1. Turn the function selector **[2]** to position **A** (temperature).
  - ▶ The temperature symbol lights up.
2. Use the intensity selector **[3]** to set the temperature to 80 °C.
3. Press the intensity selector **[3]**.
  - ▶ The intensity selector **[3]** lights up.
4. Turn the function selector **[2]** to position **C** (light).
  - ▶ The light symbol lights up.
5. Use the intensity selector **[3]** to set the light to 50%.
6. Press the intensity selector **[3]**.
  - ▶ The intensity selector **[3]** lights up.
7. Turn the function selector **[2]** to position **D** (fan).
  - ▶ The fan symbol lights up.
8. Use the intensity selector **[3]** to set the light to 10%.
9. Press the intensity selector **[3]**.
  - ▶ The intensity selector **[3]** lights up.
10. Turn the function selector **[2]** to position **G** (user programs).
  - ▶ The user symbol lights up.
11. Use the intensity selector **[3]** to select user program 2.
12. Press the intensity selector **[3]** for one second.
  - ▶ The intensity selector flashes.
  - ▶ The settings are stored in user program 2.

## 12. The Eco-function

The Eco-function allows you to save energy in breaks between sauna sessions. When the Eco-function is activated, the connected devices run with reduced power. You can choose between a 20-, 40- or 60-minute sauna break.

The sauna heater is switched on again before the end of the break. In this way the preset temperature is reached again at the end of the sauna break.

Perform the following steps to activate the Eco-function:

1. Turn the function selector **[2]** to position **H** (Eco-function).
  - ▶ The Eco symbol lights up.
2. Use the intensity selector **[3]** to set the preferred duration of the break.
  - E20 stands for a 20-minute sauna break.
  - E40 stands for a 40-minute sauna break.
  - E60 stands for a 60-minute sauna break.
3. Press the intensity selector **[3]**.
  - ▶ The intensity selector **[3]** lights up.
  - ▶ Additional display **[1]** displays in how many minutes the sauna heater is to be switched on in order to reach the preset temperature before the end of the sauna break.

## 13. Cleaning and maintenance

### 13.1. Cleaning

---

#### **ATTENTION!**

#### ***Damage to the unit***

The sauna control unit is protected against jets of water, however direct contact with water could still damage the unit.

- Never immerse the device in water.
  - Never pour water over the device.
  - Never clean the device with a cloth which is too wet.
- 

1. Immerse a cleaning cloth in a mild, soapy solution.
2. Wring the cleaning cloth out well.
3. Wipe the sauna control unit housing carefully.

### 13.2. Maintenance

The sauna control unit is maintenance-free.

## 14. Troubleshooting

### Error messages

The sauna control unit is equipped with diagnostic software which monitors system statuses when it switches on and during operation. As soon as the diagnostic software identifies an error, the sauna control unit switches the sauna heater off.

Errors are indicated by a recurring warning tone and by flashing on the function selector **[2]** and the intensity selector **[3]**. Furthermore, "Err" appears in the additional display **[1]**. The error number appears in the intensity display **[4]**.

Switch the sauna control unit off using the ON/OFF switch **[6]** and rectify the error before switching the sauna control unit on again.

The following table describes the possible errors and their causes. If necessary, tell the error number to your customer service specialist.

<i>Error</i>	<i>Description</i>	<i>Cause/rectification</i>
01	Safety shut-off	An object has been placed on the sauna heater. Remove any objects before starting up the sauna heater again.
02	Safety temperature limiter	The maximum temperature of 139 °C has been exceeded above the heater.
04F1	Heater sensor error	Defective heater sensor, poor contact, or short circuit.
05	Foil sensor error	Defective foil sensor, poor contact, or short circuit.
06F2	Bench sensor error	Defective bench sensor, poor contact, or short circuit.
08	Foil sensor excess temperature	The maximum foil temperature of 100 °C was exceeded.

EN

## 15. Disposal



- Please dispose of packaging materials in accordance with the applicable disposal regulations.
- Used devices contain reusable materials and hazardous substances. Therefore, do not dispose of your used device with household waste, but do so in accordance with the locally applicable regulations.

## 16. Technical data

### **Ambient conditions**

Storage temperature:	-25 °C to +70 °C
Ambient temperature:	-10 °C to +40 °C
Relative humidity:	max. 95%

### **Sauna control unit**

Dimensions:	307 x 175 x 57 mm
Switched voltage/three-phase 3N:	400 V AC
Frequency:	50 Hz
Contact rating/heater:	3 x 3.5 kW
Switched current per phase/heater:	16 A
Contact rating/additional output (dimnable)	500 W
Contact rating/additional output (switchable)	3.5 W
Switched current/additional output:	16 A
Status output:	24 V/200 mA
Rated voltage:	230 V
Protection type (protected against jets of water):	IPX4
Connection to the mains supply as fixed wiring (fixed connection)	

### **Light**

Contact rating:	100 W
Fuse:	1A T

### **Fan**

Contact rating:	100 W
Fuse:	1A T

### **Setting ranges**

Temperature:	30 °C to 110 °C
--------------	-----------------

**Thermal safety**

---

Heater sensor with excess temperature fuse (139 °C shut-off temperature)

Adjustable automatic heating period (6 h, 12 h, 18 h, 24 h)\*

Optional single-sensor mode or two-sensor mode

**Connection cables**

---

Power supply cable: min. 5 x 2.5 mm<sup>2</sup>

Heater supply cable (temperature-resistant up to 150 °C): min 2.5 mm<sup>2</sup>

Sensor wires (temperature-resistant up to 150 °C): min 0.75 mm<sup>2</sup>

Light wire: min. 1.5 mm<sup>2</sup>

Fan wire: min. 1.5 mm<sup>2</sup>

\* EN 60335-2-53 specifies a heating time limitation of 6 h for saunas for private use. For saunas in hotels, apartment blocks and similar locations, a maximum heating period limit of 12 hours is permissible. Extending the heating period limit to 18 hours or 24 hours is only permitted in public saunas.







WORLD OF WELLNESS

**sentiotec GmbH world of wellness** Oberregauer Straße 48 4844 Regau, Austria

T +43 (0) 7672/277 20-800 F +43 (0) 7672/277 20-801

E [info@sentiotec.com](mailto:info@sentiotec.com) [www.sentiotec.com](http://www.sentiotec.com)